

STEP 1

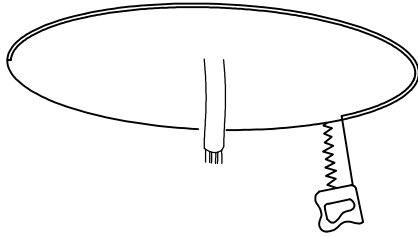

Model	Cutout size
D400	∅386mm
D500	∅484mm
D600	∅579mm
D800	∅764mm
D1000	∅984mm
D1200	∅1184mm

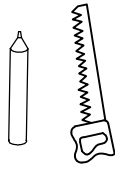

STEP 2

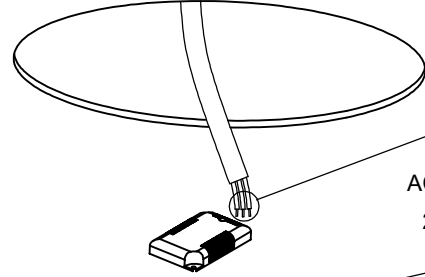

AC-L GND AC-N
200-240VAC

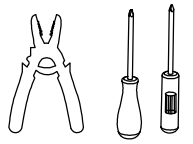
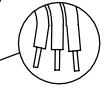

STEP 3

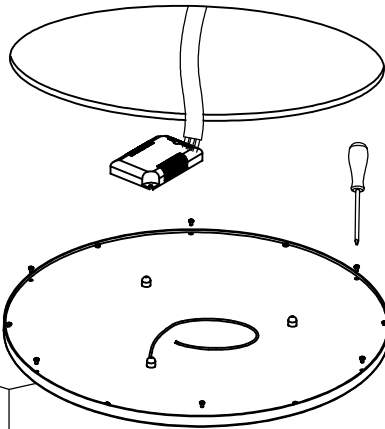

STEP 4

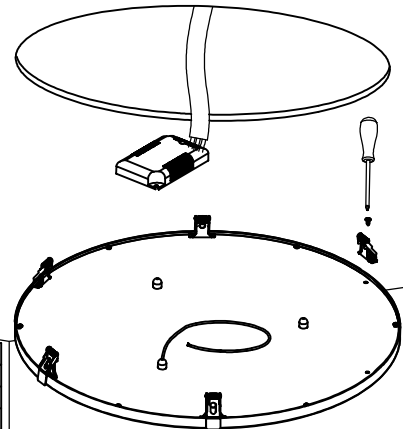

Model	Clip Qty
D400	4 PCS
D500	4 PCS
D600	6 PCS
D800	8 PCS
D1000	10 PCS
D1200	10 PCS



STEP 5



Transparent or Green(LED-)



Gold or Silvery(LED+)

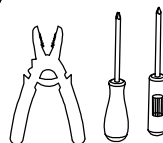
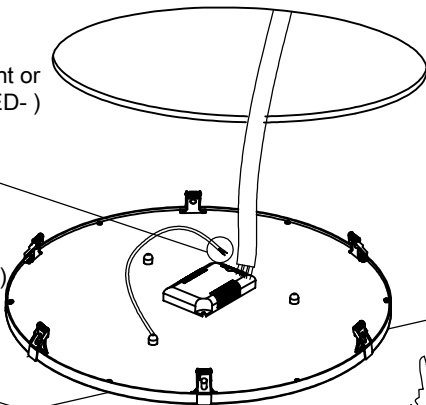

STEP 6

